

1

2

3

4

5

6

A

A

B

B

C

C

D

D

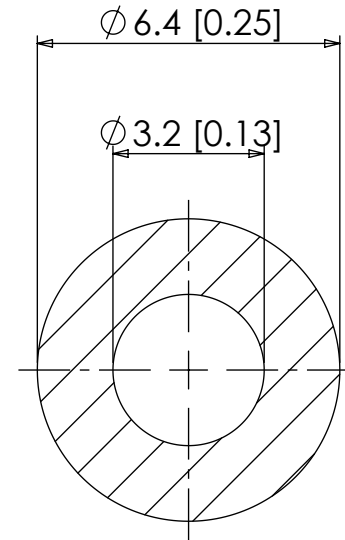
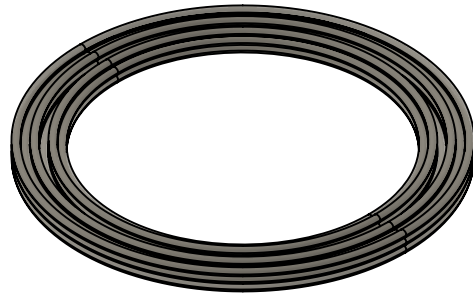

CROSS SECTION OF HOSE

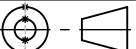
1				16/10/2024	FIRST RELEASE
REV	CREATED	CHECKED	APPROVED	REV DATE	REVISION SUMMARY
MATERIAL: FLUORINATED ETHYLENE PROPYLENE (FEP)					
THIS DRAWING IS CONFIDENTIAL AND IS THE PROPERTY OF THE WEST GROUP LTD AND MAY NOT BE REPRODUCED IN WHOLE OR IN PART, OR USED FOR ANY OTHER PURPOSE OTHER THAN THAT FOR WHICH IT IS SUPPLIED. ALL RIGHTS IN RESPECT OF PATENTS, DESIGN AND COPYRIGHTS RESERVED.				 WEST GROUP LTD, UK TEL: +44 (0) 23 9226 6031 WWW.WESTGROUP.CO.UK SALES@WESTGROUP.CO.UK	
TITLE: NATURAL FLUORINATED ETHYLENE PROPYLENE (FEP) TUBING, 57 SHORE D, 1/8" ID x 1/4" OD - 30M					
	DIM'S mm[inch]	SCALE NTS	SIZE A4	SHEET 1 / 1	DOCUMENT NUMBER E-T-240024
					REVISION 1

1

2

3

4

5

6